

TRF150

TRANSPORTEUR A ROULEAUX

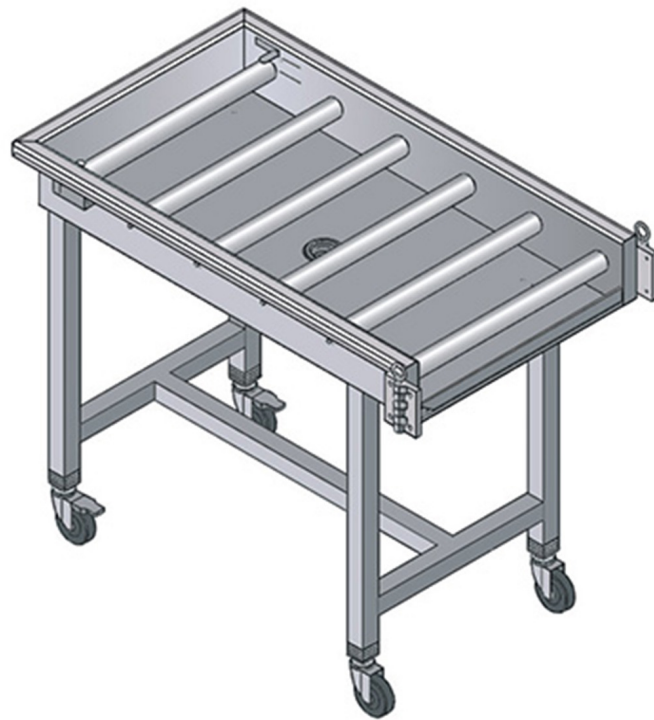

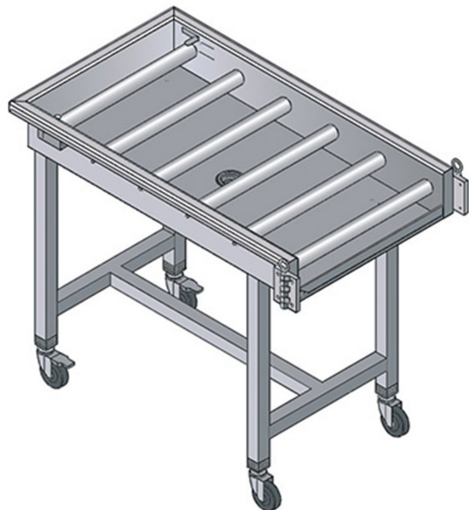

CARACTÉRISTIQUES TECHNIQUES

Largeur: 1500 mm
Profondeur: 590 mm
Hauteur: 890 mm
Volume: 0.53 m³

