

# WT100E

ENTRY TABLE

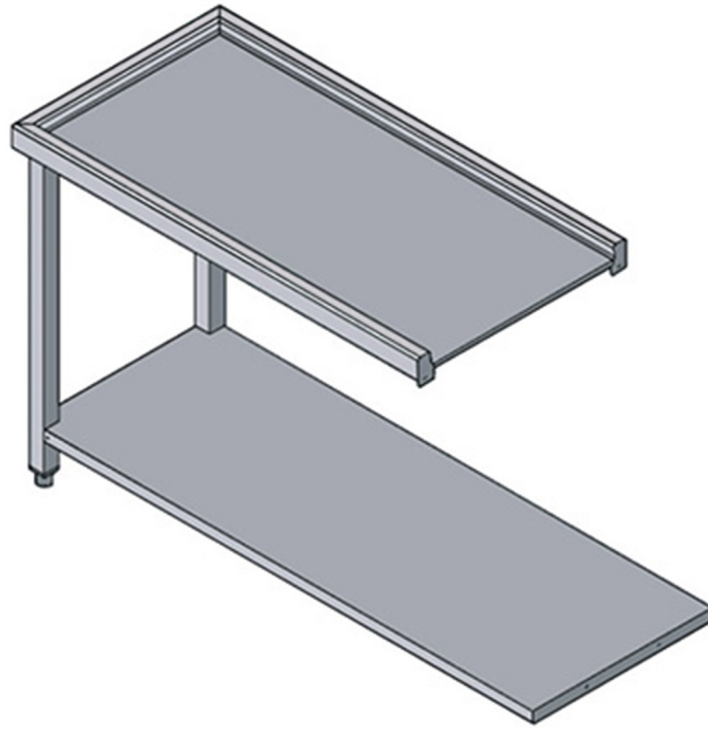

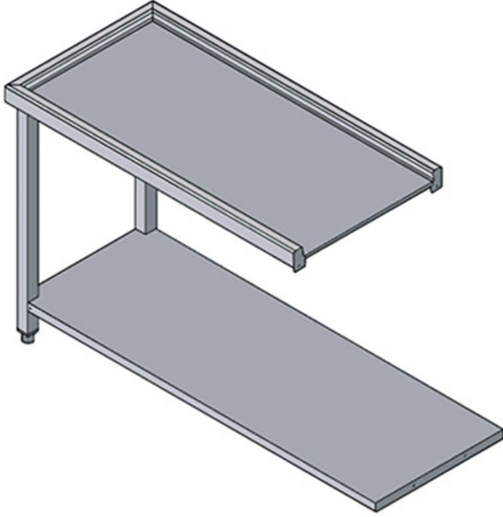

## TECHNICAL SPECIFICATIONS

**Width:** 1130 mm

**Depth:** 580 mm

**Height:** 870 mm

**Volume:** 0.58 m<sup>3</sup>

