

TRF200

ROLLER CONVEYOR

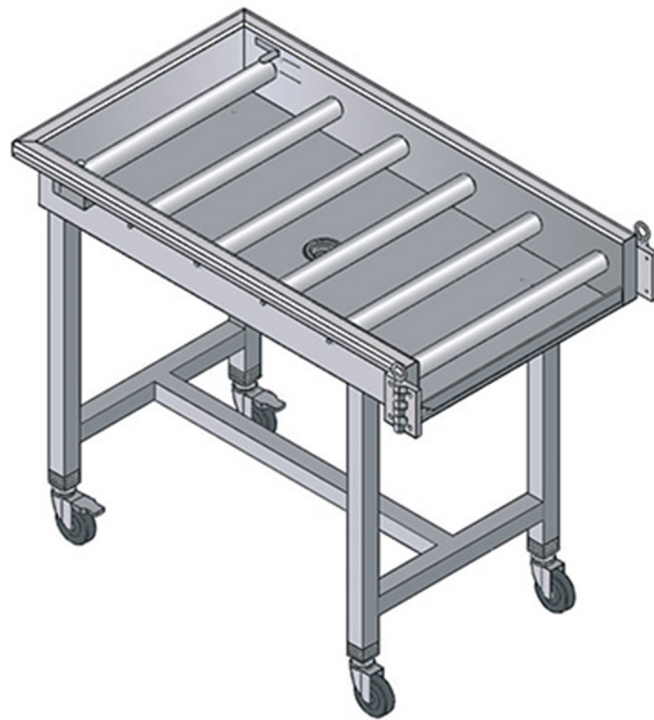



TECHNICAL SPECIFICATIONS

Width: 2000 mm

Depth: 590 mm

Height: 890 mm

Volume: 0.53 m³

