

P60E

ENTRY TABLE FOR MODELS ATR1500 AND ATR1800

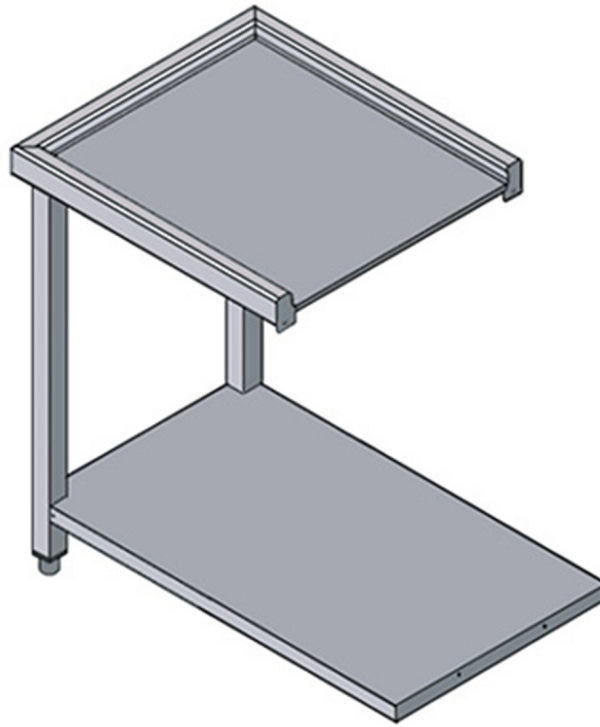

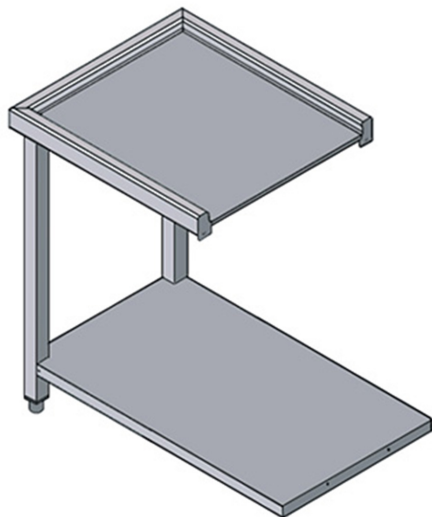

TECHNICAL SPECIFICATIONS

Width: 630 mm
Depth: 580 mm
Height: 870 mm
Volume: 0.31 m³

